



A Unique Graphic Display System

The newest of APCO's extensive range of modular sign systems. UniVUE is a low profile graphic display system like no other. Featuring a unique look, UniVUE is modular, updatable and vandal resistant, with graphics protected by a non-glare lens. Ideal for digital printing output, paper displays, ADA plaques, vinyl graphics and more, UniVUE is the perfect choice!



Low Profile Assembly

Standard Sizes

- 1/4" (6mm) Depth
- 2" h x 6" w (50mm x 150mm)
- 2" h x 8.5" w (50mm x 215mm)

Standard Finishes

- Anodized Black
- Anodized Satin Silver

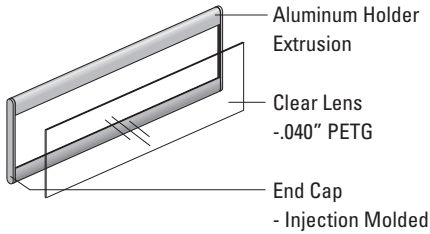

Standard Assembly

Single Column

Over 20 Standard Sizes

- 5/8" (16mm) Depth
- from 4" h x 4" w (100mm x 100mm) to 22" h x 36" w (560mm x 915mm)

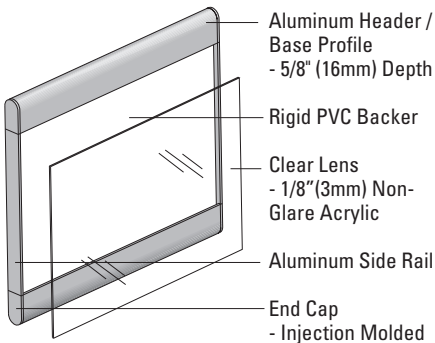

How the System Works



Using suction cup tool, lift up on protective lens.



Pull bottom of lens out and downward to remove.



Remove paper insert.

Display Options

APCO offers the UniVUE product with a ClearLens for paper displays and digital output. In addition, UniVUE is also compatible with a wide range of other insert materials (Not supplied by APCO).



Standard Paper Insert w/ Clear Lens
(Paper Insert by Others)



Braille/Tactile Plaques (By Others)

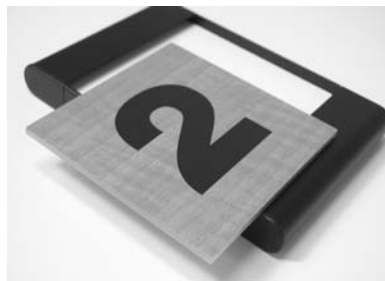

Simulated Wood Plaques or Other Custom Substrates.
(By Others)



Custom Laminate Substrates or Bands (By Others) Can
Be Applied to Clear Lens.

Easily Apply Color or Decorative Accents with Vinyl

The unique design of UniVUE's top and bottom edge profiles provides an ideal shape and surface area for the application of a vinyl cladding. This allows all signmakers the ability to easily apply color and/or decorative accents to the UniVUE sign without painting.

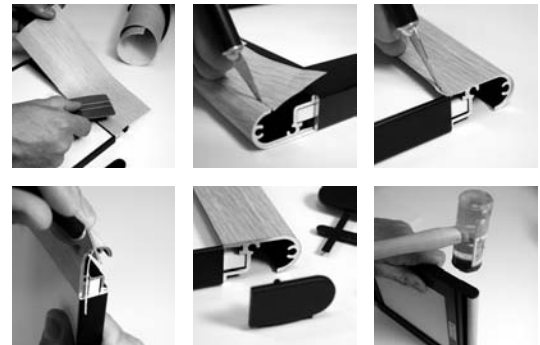

Wall Signs - Surface Mount



Signs are attached to a wall/door surface with double-sided vinyl tape or concealed mechanical fasteners, depending upon size of the sign, wall surface, etc. mechanical fasteners are recommended for larger signs. Recessed fastener holes are included on signs with an "MF" code suffix. Fasteners not provided by APCO.

Display Size (H x W)	Product Code	Description
2" x 6"	UVR0206(H)	2" x 6" Wall Sign - Single Profile
2" x 8-1/2"	UVR0285(H)	2" x 8-1/2" Wall Sign - Single Profile
4" x 4"	UVR0404(H)	4" x 4" Wall Sign
4" x 8-1/2"	UVR0485(H)	4" x 8-1/2" Wall Sign
4" x 11"	UVR0411(H)	4" x 11" Wall Sign
4" x 17"	UVR0417(H)	4" x 17" Wall Sign
4" x 24"	UVR0424(H)	4" x 24" Wall Sign
6" x 6"	UVR0606(H)	6" x 6" Wall Sign
6" x 8-1/2"	UVR0685(H)	6" x 8-1/2" Wall Sign
6" x 11"	UVR0611(H)	6" x 11" Wall Sign
6" x 17"	UVR0617(H)	6" x 17" Wall Sign
6" x 24"	UVR0624(H)	6" x 24" Wall Sign
8-1/2" x 8-1/2"	UVR8585(H)	8-1/2" x 8-1/2" Wall Sign
8-1/2" x 11"	UVR8511(H)	8-1/2" x 11" Wall Sign
11" x 8-1/2"	UVR1185(H)	11" x 8-1/2" Wall Sign
11" x 11"	UVR1111(H)	11" x 11" Wall Sign
11" x 17"	UVR1117(H)	11" x 17" Wall Sign
17" x 11"	UVR1711(H)	17" x 11" Wall Sign
17" x 17"	UVR1717(H)MF	17" x 17" Wall Sign w/ Mech. Fastener Holes
17" x 22"	UVR1722(H)MF	17" x 22" Wall Sign w/ Mech. Fastener Holes
22" x 17"	UVR2217(H)MF	22" x 17" Wall Sign w/ Mech. Fastener Holes
22" x 22"	UVR2222(H)MF	22" x 22" Wall Sign w/ Mech. Fastener Holes
22" x 28"	UVR2228(H)MF	22" x 28" Wall Sign w/ Mech. Fastener Holes
22" x 36"	UVR2236(H)MF	22" x 36" Wall Sign w/ Mech. Fastener Holes
28" x 22"	UVR2822(H)MF	28" x 22" Wall Sign w/ Mech. Fastener Holes

Wall Signs with Split Columns



UniVUE's split-column feature greatly expands the available solutions and applications of an already versatile product. Available in several standard sizes, in two or three column configurations, the Split-Column feature is ideal for menu boards, building directories, and advertising displays.

Display Size (H x W)	Product Code	Description
Qty(2) 11" x 8.5"	UVR1185-2SC(H)MF	11"(h) x 17"(w) for TWO 11"x8.5" Displays
Qty(2) 17"x11"	UVR1711-2SC(H)MF	17"(h) x 22"(w) for TWO 17"x11" Displays
Qty(3) 17"x11"	UVR1711-3SC(H)MF	17"(h) x 33" for THREE 11"x8.5" Displays
Qty(2) 22"x17"	UVR2217-2SC(H)MF	22"(h) x 34"(w) for TWO 22" x 17" Displays
Qty(3) 22"x17"	UVR2217-3SC(H)MF	22"(h) x 51"(w) for THREE 22"x17" Displays

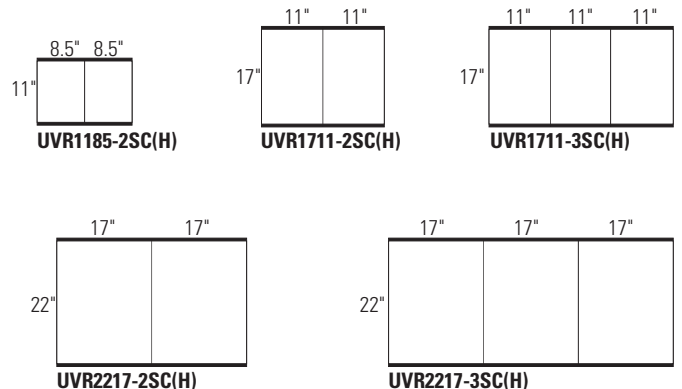

Wall Signs with Horizontal Divider

NEW!



The UniVUE Horizontal Divider feature is ideal for applications where one or more displays are needed within the same frame. Many times, this is the case for room or suite ID signs featuring a permanent room identification plaque (often Braille/tactile) as well as a more temporary and updatable display for an employee name, hours of operation, etc.

Display Size (H x W)	Product Code	Description
6" x 2.5" x 8.5"	UVR8585-VD6(H)	Dual Display frame w/Horizontal Divider
4" x 4" x 8.5"	UVR0885-VD4(H)	Dual Display frame w/Horizontal Divider
8.5" x 3" x 8.5"	UVR11585-VD85(H)	Dual Display frame w/Horizontal Divider
11" x 6" x 11"	UVR1711-VD11(H)	Dual Display frame w/Horizontal Divider

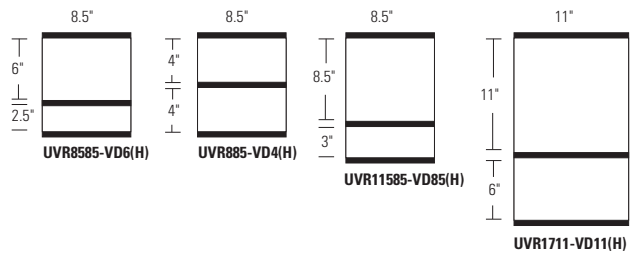

Wall Signs - Projection Mount

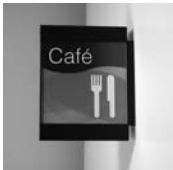

Signs are attached back-to-back via a unique, aluminum mounting bracket featuring a rectangular shape. The modular mounting bracket allows for a fast and easy, yet secure installation via concealed fasteners. Mechanical fasteners for attachment of the bracket to the wall are not included.

Display Size (H x W)	Product Code	Description
6" x 6"	UVR0606(H)PWW	6" x 6" Projection Sign/6" bracket
8-1/2" x 8-1/2"	UVR8585(H)PWW	8-1/2" x 8-1/2" Projection Sign/8.5" bracket
11" x 11"	UVR1111(H)PWW	11" x 11" Projection Sign/11" bracket
11" x 8-1/2"	UVR1185(H)PWW	11" x 8-1/2" Projection Sign/11" bracket

Ceiling Signs - Double Sided



Signs are attached back-to-back via a unique, aluminum mounting bracket featuring a rectangular shape. The modular mounting bracket allows for a fast and easy yet secure installation, either flush to the ceiling surface via concealed fastener or wire suspended. Mechanical fasteners for flush attachment or cable for wire suspension is not included. Any above ceiling structural support required is the responsibility of the installer.

Display Size (H x W)	Product Code	Description
8" x 36"	UVR0836(H)CM	8" x 36" Ceiling Sign - Double Sided
8" x 48"	UVR0848(H)CM	8" x 48" Ceiling Sign - Double Sided
12" x 36"	UVR1236(H)CM	12" x 36" Ceiling Sign - Double Sided
12" x 48"	UVR1248(H)CM	12" x 48" Ceiling Sign - Double Sided
18" x 48"	UVR1848(H)CM	18" x 48" Ceiling Sign - Double Sided
18" x 60"	UVR1860(H)CM	18" x 60" Ceiling Sign - Double Sided

Office Partition - Pin Attachment

Unique, low profile pins are bonded to the back side of 2" UniVUE signs allowing for easy attachment to fabric surfaces. Sign is sold with Pins attached.



Display Size (H x W)	Product Code	Description
2" x 6"	UVR0206(H)PIN	2" X 6" Sign w/Pins
2" x 8-1/2"	UVR02085(H)PIN	2" x 8-1/2" Sign w/Pins

Desk/Counter Sign Mounting Clip

A radius, satin anodized aluminum desk stand bracket is attached to the back side of a 2" UniVUE sign enabling it to rest at an optimal viewing angle. Sign is sold separately.



Product Code	Compatible Signs	Description
ARDSA-STD	2" X 6" UVR0206(H) 2" x 8-1/2" UVR0285(H)	Satin anodized aluminum desk sign attachment bracket for 2" signs. Attachment tape included.

Office Partition - Panel Clip Attachment

An adjustable two-part, frost clear extruded plastic clip is adhered to the back of 2" UniVUE signs enabling them to fit over the top of office partitions from 1-1/8" to 2-1/4" thick. Custom panel clips are also available. Consult APCO for details. Signs are sold separately.



Product Code	Compatible Signs	Description
UVPC	2" x 8-1/2" UVR0285(H)	Two-part, extruded plastic panel clip for attachment to 2" UniVUE signs. Attachment tape included.

Free Standing

APCO's newest free-standing sign solution, the FS300 is a lightweight, single post pedestal featuring a modular UniVUE sign displayed at a 60 degree angle.



Display Size (H x W)	Product Code	Description
8-1/2" x 11"	FS300/UVR8511(H)	Stanchion with Single-Sided / Angled Display
11" x 8-1/2"	FS300/UVR1185(H)	Stanchion with Single-Sided / Angled Display
17" x 11"	FS300/UVR1711(H)	Stanchion with Single-Sided / Angled Display

Post Specifications
 1-1/2" Diameter Extruded Aluminum
 42" Height to Middle of Display
 Standard Satin or Black Anodized

Base Specifications
 12" Diameter Steel
 Silver or Black Powder Coated

Sample Kit / Accessories

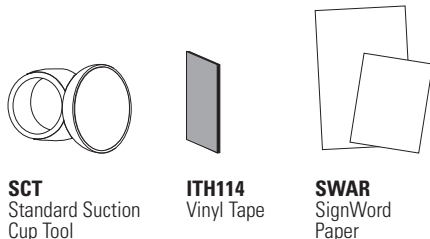

SignWord Paper Colors
A72 Bone White
A00 White on Reverse
A43 Putty
A94 Sand on Reverse
A78 Pearl Grey

Product Code	Qty / Length	Description
USK	1 Case/Kit	Sample Kit with Case and 3 Display Boards
SCT	1	Suction Cup Tool for Removal of ClearLens
SWAR8511	1 Pack of 50	11" x 8-1/2" Coated SignWord Paper
SWAR1711	1 Pack of 50	17" x 11" Coated SignWord Paper
ITH114 *	1 Roll (100ft)	1/2" x 1/16" Double Sided Tape for Wall Mount Signs

* The success of vinyl tape sign installation depends upon a wide range of factors beyond APCO's control, such as wall surface, weight of the sign, preparation and cleaning of the surface area, etc. APCO is not responsible for installation failures or damages resulting from such failures.

Multi-Column Modular Directory & Display Units

The Multi-Column and Modular Directory solutions of UniVUE help make what is an already versatile graphic display system even better.

UniVUE's modular directories feature removable cartridges of APCO aluminum InsertSlot bands which house pre-perforated, laser printed paper strips.

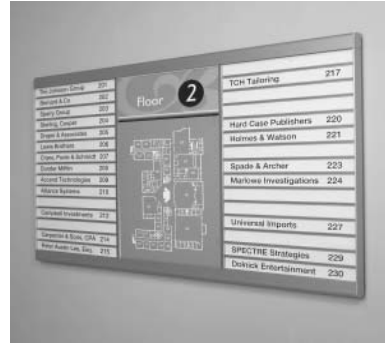

Directories with 1-1/8" x 11" Bands

These UniVUE directories feature removable cartridges of 30mm (1-1/8") x 11" aluminum insert slot bands. Visible height options are 17" or 22". A 1/4" wide divider separates the columns.

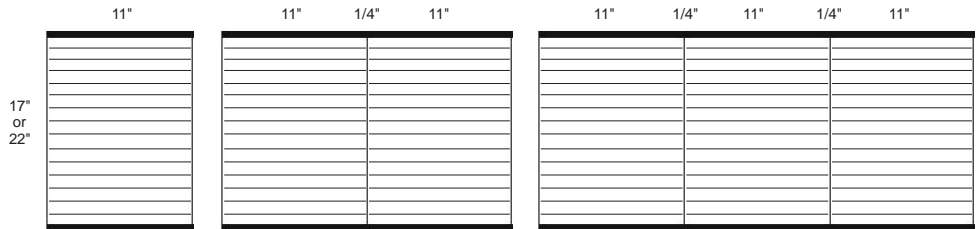

UVR1711-30IS
17"(h) / 14 Bands

UVR1711(2)-30IS
17"(h) / 2-Columns / 28 Bands

UVR1711(3)-30IS
17"(h) / 3-Columns / 42 Bands

UVR2211-30IS
22"(h) / 19 Bands

UVR2211(2)-30IS
22"(h) / 2-Columns / 38 Bands

UVR2211(3)-30IS
22"(h) / 3-Columns / 57 Bands

Directories with 4" Modular Header & 1-1/8" x 11" Bands

Directories feature a 4"(h) satin anodized aluminum header behind a removable clear acrylic lens at the top of the sign. A 1" aluminum divider separates the header from the directory.

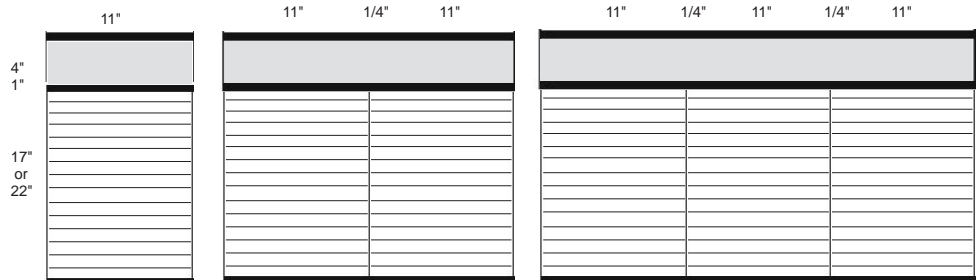

UVR1711-H30IS
17"(h) / 14 Bands / 4" Header

UVR1711(2)-H30IS
17"(h) / 2-Columns / 28 Bands / 4" Header

UVR1711(3)-H30IS
17"(h) / 3-Columns / 42 Bands / 4" Header

UVR2211-H30IS
22"(h) / 19 Bands / 4" Header

UVR2211(2)-H30IS
22"(h) / 2-Columns / 38 Bands / 4" Header

UVR2211(3)-H30IS
22"(h) / 3-Columns / 57 Bands / 4" Header

There are several options for header graphics:

- applied to ClearLens
- applied to Aluminum Insert, OR
- a digitally printed graphic display may be placed between the Aluminum Insert and the ClearLens

Combo-Directories with Graphic Display Areas & 1-1/2" x 11" Bands

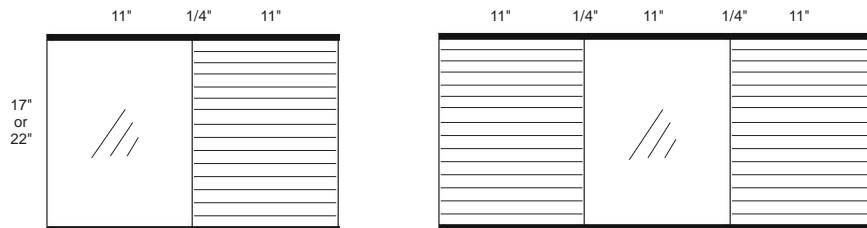

UVR1711(2)-CL30IS
17"(h) / 14 Bands

UVR1711(3)-CL30IS(2)
17"(h) / 28 Bands

UVR2211(2)-CL30IS
22"(h) / 19 Bands

UVR2211(3)-CL30IS(2)
22"(h) / 38 Bands



Combo-Directories with Graphic Display Areas & 1-1/8" x 11" Bands & 4" Modular Header



(See Reverse Page for 4" Header details)

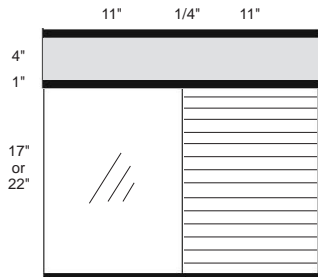

UVR1711(2)-HCL30IS
 17"(h) Displays / 14 Bands /
 17"x11" ClearLens / 4" Header

UVR2211(2)-HCL30IS
 22"(h) Displays / 19 Bands /
 22"x11" ClearLens / 4" Header

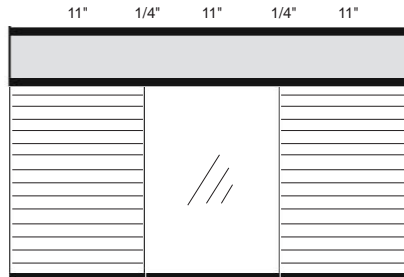

UVR1711(3)-HCL30IS(2)
 17"(h) Displays / 28 Bands /
 17"x11" ClearLens / 4" Header

UVR2211(3)-HCL30IS(2)
 22"(h) Displays / 38 Bands /
 22"x11" ClearLens / 4" Header

Directional Sign Configurations with 2-3/8" x 14" Bands

Same construction detail as the directories but feature 60mm (2-3/8") x 14" aluminum bands/paper inserts more suitable for directional signs and arrows.

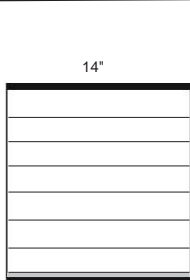

UVR1714-60IS
 17"(h) / 7 Bands

UVR2214-60IS
 22"(h) / 9 Bands

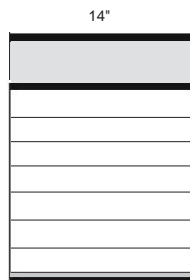

UVR1714-H60IS
 17"(h) / 7 Bands

UVR2214-H60IS
 22"(h) / 9 Bands